

केंद्रीय विद्यालय संगठन क्षेत्रीय कार्यालय रायपुर
Kendriya Vidyalaya Sangathan Regional Office Raipur



SCIENCE



Class - X

Question Bank Term- II 2021-22

केंद्रीय विद्यालय संगठन क्षेत्रीय कार्यालय रायपुर

Kendriya Vidyalaya Sangathan Regional Office Raipur

MESSAGE FROM DUPUTY COMMISSIONER



It is a matter of great pleasure for me to publish study material for different subjects of classes X and XII for Raipur Region. Getting acquainted and familiarized with the recent changes in curriculum and assessment process made by CBSE vide Circular No. 51 and 53 issued in the month of July 2021 will help students to prepare themselves better for the examination. Sound and deeper knowledge of the Units and Chapters is must for grasping the concepts, understanding the questions. Study materials help in making suitable and effective notes for quick revision just before the examination.

Due to the unprecedented circumstances of COVID-19 pandemic the students and the teachers are getting very limited opportunity to interact face to face in the classes. In such a situation the supervised and especially prepared value points will help the students to develop their understanding and analytical skills together. The students will be benefitted immensely after going through the question bank and practice papers. The study materials will build a special bond and act as connecting link between the teachers and the students as both can undertake a guided and experiential learning simultaneously. It will help the students develop the habit of exploring and analyzing the **Creative & Critical Thinking Skills**. The new concepts introduced in the question pattern related to case study, reasoning and ascertain will empower the students to take independent decision on different situational problems. The different study materials are designed in such a manner to help the students in their self-learning pace. It emphasizes the great pedagogical dictum that '*everything can be learnt but nothing can be taught*'. The self-motivated learning as well as supervised classes will together help them achieve the new academic heights.

I would like to extend my sincere gratitude to all the principals and the teachers who have relentlessly striven for completion of the project of preparing study materials for all the subjects. Their enormous contribution in making this project successful is praiseworthy.

Happy learning and best of luck!

Vinod Kumar
(Deputy Commissioner)

केंद्रीय विद्यालय संगठन क्षेत्रीय कार्यालय रायपुर
Kendriya Vidyalaya Sangathan Regional Office Raipur

Our Patorn

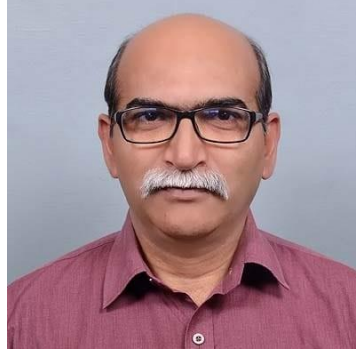

Vinod Kumar
Deputy Commissioner
KVS RO Raipur



Smt. Biraja Mishra
Assistant Commissioner
KVS RO Raipur



Sh. A.K. Mishra
Assistant Commissioner
KVS RO Raipur



Sh. N.K. Sinha
Principal
KV Ambikapur

BLUE PRINT OF MODEL SAMPLE PAPER

CLASS-X SCIENCE (2021-22)

S.N.	UNIT	MARKS	Chapters	SA-I	SA-II	LA	TOTAL MARKS
1	Chemical substances- Nature and behaviour : Chapter 4 and 5	10	4- Carbon and its compounds	2(1)	3(1)	-	5
2	World of living : Chapter 8 and 9	13	5- Periodic classification of elements	2(1)	3(1)	-	5
3	Effects of Current : Chapter 12 and 13	12	8- How do organisms reproduce	2(2)	-	-	4
4	Natural resources : Chapter 15	05	9- Heredity and evolution	2(1)	3(1)	4(1)	9
			12- Electricity	-	3(2)		6
			13- Magnetic effects of electric current	2(1)	-	4(1)	6
			15- Our Environment	2(1)	3(1)		5
		40	TOTAL QUESTIONS	(7)	(6)	(2)	40

NOTE :1)Number of questions written in bracket.

2) SA-I is 2 marks short answer question.

3) SA-II is 3 marks short answer question.

4) LA is 4 marks long answer question.

MODEL QUESTION PAPER

CLASS-X SCIENCE

TERM-II (2021-22)

Max. Marks- 40

Time allowed: 2 hours

General instructions :

- i) All questions are compulsory.
- ii) The question paper has **three sections** and **15 questions**. All questions are compulsory.
- iii) Section-A has 7 questions of 2 marks each; Section-B has 6 questions of 3 marks each; and Section-C has 2 case based questions of 4 marks each.
- iv) Internal choices have been provided in some questions. A student has to attempt only one of the alternatives in such questions.

SECTION- A

1. In the Periodic Table given below, Lithium, Carbon, Oxygen and Neon are placed in their correct positions and the positions of nine other elements are represented by letters. These letters are not the symbols for the elements ?

1	2	13	14	15	16	17	18
Lithium			Carbon		Oxygen	L	Neon
X			E		G	Q	
Y						R	
Z						T	

With reference to the table, answer the following questions ;

- (a) Name the family of elements represented by L, Q, R and T.
- (b) Name one element in each case occurring in groups 2, 13 and 15.

2. Diamond and graphite show different physical properties although they are made up of carbon and show same chemical properties.

- (a) What is the property called?
- (b) Give another example of this property of carbon.

3. What does the diagram depict?

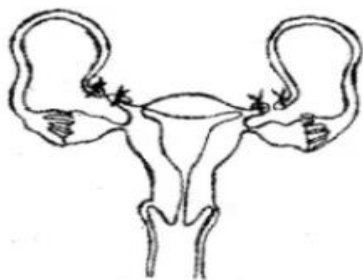

- (a) Name and define this surgical method.
- (b) Why is this surgical method adopted?

4. (a) How does Plasmodium reproduce? Is this method sexual or asexual?

(b) Name some artificial methods of vegetative propagation.

5. Crossing of a pea plant with purple flower and pea plant with white flowers produces 50 plants with only purple flowers. On selfing, the plants produced 470 plants with purple flowers and 160 with white flowers. Explain the genetic mechanism accounting for the above results.

OR

Differentiate between genotype and phenotype.

6. Magnetic field lines around a bar magnet are shown in the figure below. A student makes a statement that magnetic field at point A is stronger than at point B. State, whether the statement is correct or incorrect. Explain.

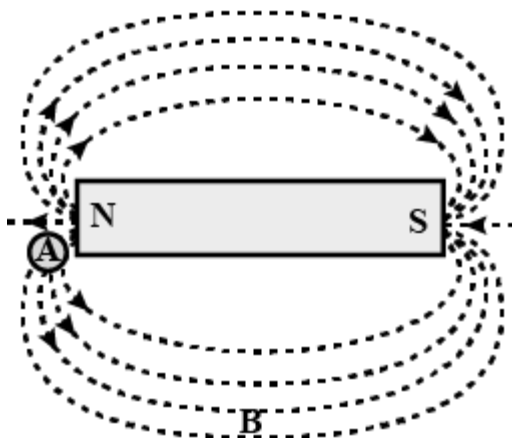

OR

Draw a rough sketch of the pattern of field lines due to a

(a) Current flowing through a circular coil and

(b) Solenoid, carrying current.

7. A geographical area contains organisms like snake, grasshopper, peacock, grass and frog. If pesticides were used in this area to kill insects, which among the organisms will have the maximum amount of pesticide. Name and define the phenomenon involved.

OR

Give reason to justify the following:

(a) The existence of decomposers is essential in the biosphere.

(b) Flow of energy in a food chain is unidirectional.

SECTION - B

8. Two elements M and N belong to groups I and II respectively and are in the same period of the periodic table. How do the following properties of M and N vary?

(a) Sizes of their atoms.

(b) Their metallic characters.

(c) Their valencies in forming oxides.

9. The table given below shows some information about four organic compounds P, Q, R and S.

Organic compounds	Molecular formula	Melting Point ($^{\circ}\text{C}$)	Boiling point ($^{\circ}\text{C}$)
P	C_3H_8	-188	-42
Q	C_4H_{10}	-138	-1
R	C_5H_{12}	-130	36
S	C_6H_{12}	6	80

- (a) Why are P, Q, R and S classified as hydrocarbons?
- (b) Which of these organic compounds belong to the alkane series?
- (c) Based on the information given above, state one characteristic of the alkane series.

OR

(a) State the reason why carbon can neither form C^{4+} cations nor C^{4-} anions, but forms covalent bonds.

(b) Also state reasons to explain why covalent compounds are bad conductors of electricity.

10. The gene type of green stemmed tomato plant is denoted as GG and that of purple stemmed tomato plant as gg. When these two are crossed

- (a) What colour of stem would you expect in F₁ progeny?
- (b) Give the percentage of purple stemmed plants, if F₁ off springs are self pollinated?
- (c) In what ratio would you find the gene types GG and Gg in F₂ progeny?

11.

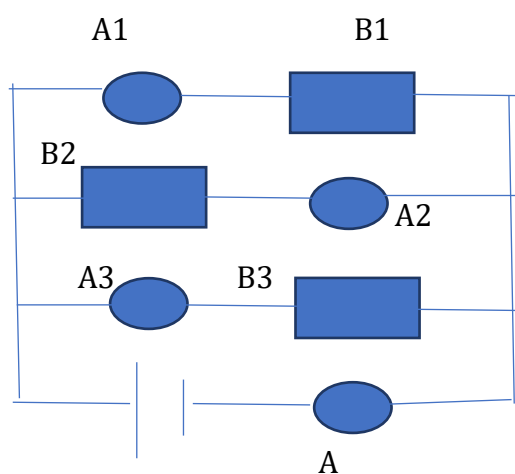

A₁, A₂, A₃ and A are ammeters connected in the circuit. B₁, B₂ and B₃ are three identical bulbs. They all are connected to Voltage source as shown in Figure.

When the three bulbs are working good and glowing, the current recorded in Ammeter A is 6A.

Answer the following:

- (a) Same amount of current will go through each bulb and the value is 2A. True or false.
- (b) If the bulb B₃ is blown away, the bulb B₁ and B₂ will start glowing more. True or false.
- (c) What will happen to all the ammeter reading if Bulb B₁ is blown away.

12. Find the equivalent resistance between points A and B.

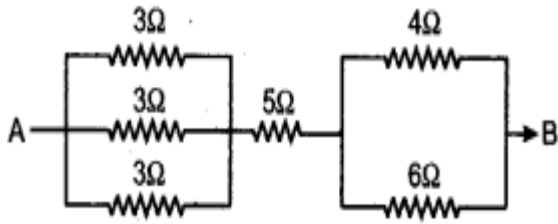

OR

In the figure given below, A, B and C are three ammeters. The ammeter B reads 0.5 A. (All the ammeters have negligible resistance).

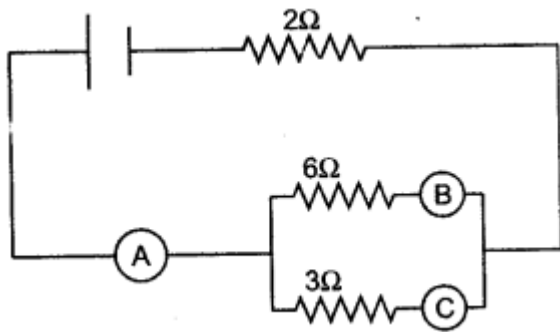

Calculate:

- (a) The readings in the ammeters A and C.
- (b) The total resistance of the circuit.

13. It is said that there is need to put a complete ban on the products containing aerosols. What are aerosols?

Why is there a demand to put a ban on them?

Name the organization which succeeded in forcing an agreement to freeze CFC production. Also mention the year.

SECTION- C

This section has 02 case based questions (14 and 15). Each case is followed by 03 sub-questions (a, b and c). Parts a and b are compulsory. However, an internal choice has been provided in part c.

14. Raghu often taunts his wife for having only daughters and no son.

- (a) As a science student how will you convince Raghu that his wife has no role in giving birth to girls only? (3 Marks).
- (b) A couple has six daughters. What is the possibility of their having a girl next time? (1 Mark)

OR

Pure bred pea plant with smooth seeds (dominant characteristic) were crossed with pure bred pea plant with wrinkled seeds (recessive characteristic). The F₁ generation was self pollinated to give rise to the F₂ generation.

- (a) What is the expected observation of the F₁ generation of plants? (1 Mark)
- (b) What is the expected observation of the F₂ generation of plants? (1 Mark)

(c) What will be the genotypic ratio of F₂ offspring, also mention whether it will be homozygous or heterozygous? (1+ 1 Mark)

15. Andre Marie Ampere suggested that a magnet must exert an equal and opposite force on a current carrying conductor, which was experimentally found to be true. But we know that current is due to charges in motion. Thus, it is clear that a charge moving in a magnetic field experience a force, except when it is moving in a direction parallel to it. If the direction of motion is perpendicular to the direction of magnetic field, the magnitude of force experienced depends on the charge, velocity (v), strength of magnetic field (B), and sine of the angle between v and B .

(a) Direction of magnetic force is given by which rule? (1 Mark)

(b) Write the statement of the rule? (2 Marks)

(c) Draw a line diagram to represent this rule. (1 Mark)

OR

Two coils C_1 and C_2 are wrapped around a non-conducting cylinder. Coil C_1 is connected to a battery and key and C_2 with galvanometer G . On pressing the key (K), current starts flowing in the coil C_1 . State your observation in the galvanometer.

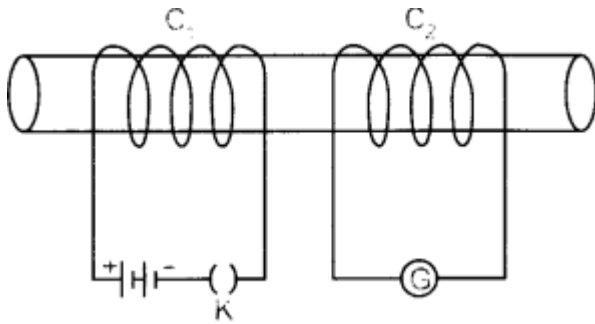

(a) When key K is pressed on. (1 Mark)

(b) When current in the coil C_1 is switched off. (1 Mark)

(c) When the current is passed continuously through coil C_1 . (1/2 Mark)

(d) Name and state the phenomenon responsible for the above observation. (1/2 + 1 Mark)

MARKING SCHEME OF SAMPLE QUESTION PAPER1

SCIENCE CLASS-X

TERM-II (2021-22)

SECTION-A

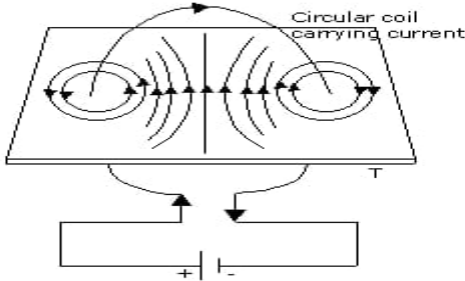
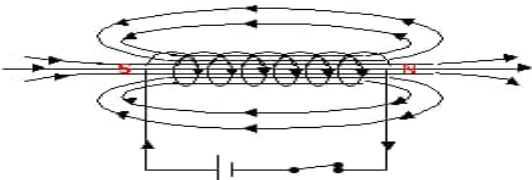
SECTION-A								
1.	a. Halogen family.(1/2 mark) b. Mg (group 2), Al (group 13), N (group 15) (1/2+ 1/2 + 1/2 mark)	2						
2.	a. Allotropy/ allotropes of carbon (1 mark) b. Buckminster fullerene (1 mark)	2						
3.	a. Tubectomy- cutting and ligating the oviducts of a woman (1/2 +1/2 mark) b. Used as a contraceptive method to avoid pregnancy(1 mark)	2						
4.	a. Plasmodium reproduce by multiple fission. Type of asexual reproduction (1/2 + 1/2 mark) b. Cutting, layering, grafting (1 mark)	2						
5.	In this breeding experiment ratio of purple to white flowers is approximately 3: 1 in F2 generation. So the ratio is according to Mendelian monohybrid cross. (1 mark) This cross also explains (i) F1 is represented only by dominant trait i.e. purple flowered plants (1/2 mark) (ii) Both the traits show segregation and thus appear in F2 generation. (1/2 mark) OR	2						
	<table border="1" style="width: 100%;"> <thead> <tr> <th style="text-align: center;">Genotype</th> <th style="text-align: center;">Phenotype</th> </tr> </thead> <tbody> <tr> <td>Genotype is the gene complement of an organism, i.e. TT or Tt for a tall plant.</td> <td>It is the expression of a character, e.g. tall plant.</td> </tr> <tr> <td>Organisms with different genotypes may have similar phenotypes, e.g.tallness with TT or Tt genotypes.</td> <td>Organisms with different phenotypes are usually with different genotypes.</td> </tr> </tbody> </table>	Genotype	Phenotype	Genotype is the gene complement of an organism, i.e. TT or Tt for a tall plant.	It is the expression of a character, e.g. tall plant.	Organisms with different genotypes may have similar phenotypes, e.g.tallness with TT or Tt genotypes.	Organisms with different phenotypes are usually with different genotypes.	
Genotype	Phenotype							
Genotype is the gene complement of an organism, i.e. TT or Tt for a tall plant.	It is the expression of a character, e.g. tall plant.							
Organisms with different genotypes may have similar phenotypes, e.g.tallness with TT or Tt genotypes.	Organisms with different phenotypes are usually with different genotypes.							
6.	Statement is correct. (1 mark) Because field lines are crowded in a region of strong magnetic field and field lines diverge in a region of weak magnetic field.(1/2 + 1/2 mark) OR (i)  (ii)  (1 +1 mark)	2						
7.	Peacock will have maximum concentration of pesticide as it lies at the top of food	2						

	<p>chain. (½ mark)</p> <p>Phenomenon- Biomagnification. (1/2 mark)</p> <p>Increase in the concentration of pollutant or pesticides at higher trophic levels. (1 mark)</p> <p>OR</p> <p>(a) Decomposers function as saprophytes and cleanse the earth from dead remains. Help in recycling of biogeochemicals, recycling of paper, metal etc.(1 mark)</p> <p>(b) The energy which is capture by autotrophs from sun or energy which passes to herbivores from autotrophs does not come back. (1 mark)</p>	
8.	<p>(a) The atomic radii of M is greater than N. (1 mark)</p> <p>(b) M is more metallic than N. (1 mark)</p> <p>(c) M has a valency of 1 and N has a valency of 2. (1 mark)</p>	3
9.	<p>a. P, Q, R and S are classified as hydrocarbons, because these compounds are made up of C and H only.(1 mark)</p> <p>b. C₃H₈, C₄H₁₀ and C₅H₁₂ all have general formula C_nH_{2n+2} thus, all of these belong to alkanes. (1 mark)</p> <p>c. They have general formula C_nH_{2n+2} and their melting point and boiling point increase with increase in molecular mass. (1 mark)</p> <p>OR</p> <p>a. Carbon which has 4 electrons in its outermost shell cannot form ionic compounds by gaining or losing electrons because</p> <p>(i) if C forms ionic bonds by gaining 4 electrons to attain a noble gas configuration then it would be difficult for 6 protons in the nucleus to hold 10 electrons.</p> <p>(ii) if C forms ionic bonds by loss of 4 electrons then it would require a lot of energy to remove these electrons from outermost shell. (1 + 1 mark)</p> <p>b. Because they do not have free electrons or ions. (1 mark)</p>	3
10.	<p>a. Colour of F1 progeny – Green. (1 mark)</p> <p>b. Percentage of purple stemmed plants in F2 generation is ¼ or 25 %. (1 mark)</p> <p>c. Ratio of genotypes GG and Gg - 1: 2. (1 mark)</p>	3
11.	<p>a. True (1/2 mark)</p> <p>Since Bulb are identical and connected in parallel with Voltage , same current will flow through each bulb. Since total current is 6A , individual current will be 2 A. (½ mark)</p> <p>b. False (½ mark)</p> <p>If B3 is blown away, the potential difference across other bulb still remains same, so same current will flow and they will glow as it is . No change. (½ mark)</p> <p>c. When B1 goes down, the current in that part becomes zero. A1 becomes zero A₂= 2A, A₃ = 2A , therefore A = 2 + 2 = 4A. (1 mark)</p>	3
12.	<p>$1/R_1 = (1/3 + 1/3 + 1/3)$ $1/R_1 = 1$ (1 mark) $R_1 = 1 \Omega$ $R_2 = 5 \Omega$ $1/R_3 = 1/4 + 1/6 = 10/24$ $R_3 = 24/10 \Omega$ (1 mark) Equivalent resistance $R_{equ} = R_1 + R_2 + R_3 = 1 + 5 + 24/10$ $R = 8.4 \Omega.$ (1 mark)</p> <p>OR</p> <p>a. P.d. across 6 Ω =P.d. across 3 Ω $6 \times 0.5 = 3 \times I_c$ $I_c = 6 \times 0.5 / 3 = 1 A.$ (1 mark) Current through A $I_A = I_B + I_C$</p>	3

	<p>$= 0.5 + 1 = 1.5 \text{ A.} (\frac{1}{2} \text{ mark})$</p> <p>b. $I/R = 1/6 + 1/3 = 3/6 = \frac{1}{2}$.</p> <p>$R = 2 \Omega (1 \text{ mark})$</p> <p>Total resistance $= 2 \Omega + R$</p> <p>$= 2 \Omega + 2 \Omega = 4 \Omega. (\frac{1}{2} \text{ mark})$</p>	
13.	<p>Aerosols are mist producing propellants used in sprays like deodorants, perfumes, after shaves, refrigerants, fire extinguishers etc. (1 mark)</p> <p>They are commonly made of chlorofluorocarbons which are strongest ozone depleting substance. Therefore there is a demand for putting a ban on them. (1 mark)</p> <p>In 1987, the United Nations Environment Programme (UNEP) succeeded. ($\frac{1}{2} + \frac{1}{2}$ mark)</p>	3
14.	<p>a. By telling Raghu that sex of the child is determined at the time of conception. Women are homogametic, i.e. they produce only one type of ova (22 + X). Males are heterogametic. They produce two types of sperms, androsperms (22 + Y) and gymnosperms (22 + X). The two types of sperms are formed in equal proportion. It is chance factor that gymnosperm fuses with the ovum (22 + X and 22 + X) resulting in the female child. The same chance is possible for the second and even the third time. In any case, for the sex of the child, only the father is responsible. (3 marks)</p> <p>b. The possibility of having a girl or boy child is equal i.e. 50% as 50% male gametes are Y type and 50% are X type. Fusion of egg with X type sperm will produce a girl child. (1 mark)</p> <p style="text-align: center;">OR</p> <p>a. All of them have smooth seeds. (1/2 mark)</p> <p>b. $\frac{1}{4}$ of them have wrinkled seeds and $\frac{3}{4}$ of them have smooth seeds. (1 mark)</p> <p>c. Genotypic ratio = 1: 2: 1 (1 mark)</p> <p>1- homozygous dominant</p> <p>2- heterozygous dominant (1 1/2 mark)</p> <p>1- homozygous recessive</p>	4
15.	<p>a. Fleming's left hand rule. (1 mark)</p> <p>b. It states that if we stretch thumb, forefinger or the index finger and the middle finger in such a way that they are mutually perpendicular to each other then the thumb gives the direction of the motion or the force acting on conductor, index finger gives the direction of magnetic field and the middle finger gives the direction of current. (2 marks)</p> <p>c.</p> <div style="text-align: center;"> </div> <p>(1 mark)</p> <p>OR</p>	4

- | | |
|--|--|
| <p>a. The galvanometer needle deflects momentarily in one direction. (1 mark)</p> <p>b. The galvanometer needle deflects again momentarily but in opposite direction to that in the previous case. (1 mark)</p> <p>c. No deflection. (½ mark)</p> <p>d. Electromagnetic induction. (½ mark)</p> <p>It is a process by which a changing magnetic field in a conductor induces a current in another conductor placed nearby.(1 mark)</p> | |
|--|--|

KENDRIYA VIDYALAYA SANGATHAN, RAIPUR REGION
BLUE PRINT (TERM-II) 2021-22
Class – X Science (086)

S.N.	NAME OF CHAPTER	S.A.(2 Marks each)	S.A.(3 Marks each)	Case based Questions	Total Marks
1	Carbon and its compounds	1(2)	1(3)		5
2	Periodic classification of elements	1(2)	1(3)		5
3	How do organisms reproduce	2(2)			4
4	Heredity and Evolution	1(2)	1(3)	1(4)	9
5	Electricity		2(3)		6
6	Magnetic effects of electric current	1(2)		1(4)	6
7	Our environment	1(2)	1(3)		5
	Total	7(2)	6(3)	2(4)	40

KENDRIYA VIDYALAYA SANGATHAN, RAIPUR REGION
MODEL QUESTION PAPER
CLASS-X SCIENCE
TERM-II (2021-22)

Max. Marks: 40

Time allowed: 2 hours

General Instructions:

- i) All questions are compulsory.**
- ii) The question paper has three sections and 15 questions. All questions are compulsory.**
- iii) Section–A has 7 questions of 2 marks each; Section–B has 6 questions of 3 marks each; and Section–C has 2 case based questions of 4 marks each.**
- iv) Internal choices have been provided in some questions. A student has to attempt only one of the alternatives in such questions.**

SECTION – A

Q.1. What are the two properties of carbon which lead to the huge number of carbon compounds we see around us.

Q.2. An atom has electronic configuration 2, 8, 7.

(a) What is the atomic number of this element?

(b) To which of the following elements would it be chemically similar?

(Atomic numbers are given in parentheses)

N (7)

F (9)

P (15)

Ar (18)

Q.3. State the changes that take place in the uterus when:

(a) Implantation of embryo has occurred.

(b) Female gamete/egg is not fertilized.

Q.4 (a). List two differences in tabular form between dominant trait and recessive trait.

(b) What percentage/proportion of the plants in the F₂ generation/progeny were round, in Mendel's cross between round and wrinkled pea plants?

OR

How did Mendel's experiments show that different traits are inherited independently? Explain.

Q.5. (a) A magnetic compass shows a deflection when placed near a current-carrying wire. How will the deflection of the compass get affected if the current in the wire is increased?

(b) What does the divergence of magnetic field lines near the ends of a current-carrying straight solenoid indicate?

OR

List the four properties of magnetic field lines.

Q.6. Illustrate the following with the help of suitable diagrams:

(a) Spore formation in Rhizopus

(b) Multiple fission in Plasmodium

Q.7. Consider the food chain: Grass \longrightarrow Deer \longrightarrow Lion.

What will happen if lions are removed from the mentioned food chain?

OR

The number of malarial patients in a village increased tremendously when large numbers of frogs were exported from the village. What could be the cause for this?

SECTION – B

Q.8. The formulae of four organic compounds are given below:



- (a) Which one of these compounds A, B, C or D is a saturated hydrocarbon?
(b) Name the functional group present in compound B.
(c) Write the chemical formula of next two members of homologous series of compound A.

OR

Write the molecular formula of the following compounds and draw their electron-dot structures:

- (i) Ethane (ii) Ethene (iii) Ethyne

Q.9. The positions of three elements A, B and C in the periodic table are indicated below:

Group 16	Group 17
—	— (First Period)
—	A (Second Period)
—	— (Third Period)
B	C (Fourth Period)

- (a) State whether element C would be a metal or a non-metal. Why?
(b) Which is the more active element, A or C? Why?
(c) Which type of ion (cation or anion) will be formed by the element C? Why?

Q.10. A blue colour flower plant denoted by BB is cross bred with that of white colour flower plant denoted by bb.

- (a) State the colour of flower you would expect in their F_1 generation plants.
(b) What must be the percentage of white flower plants in F_2 generation if flowers of F_1 plants are self-pollinated?
(c) State the expected ratio of the genotypes BB and Bb in the F_2 progeny.

Q.11. V-I graph for two wires A and B are shown in the figure. If both wires are of same length and same thickness, which of the two is made of a material of high resistivity? Give justification for your answer.

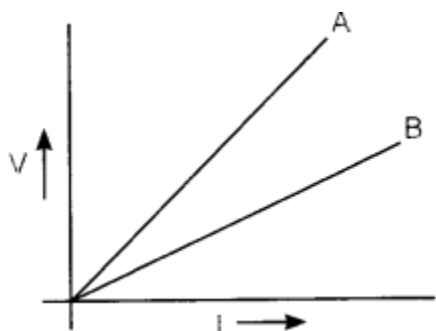

OR

Define electric power. Express it in terms of potential difference V and resistance R.

- (b) An electrical fuse is rated at 2 A. What is meant by this statement?
(c) An electric iron of 1 kW is operated at 220 V. Find which of the following fuses that respectively rated at 1 A, 3 A and 5 A can be used in it.

Q. 12.(a) With the help of an example explain how indiscriminate use of pesticides may result in the degradation of the environment.

- (b) What are the by-products of fertilizer industries? How do they affect the environment?

Q.13. The figure below shows three cylindrical copper conductors along with their face areas and lengths. Discuss in which geometrical shape the resistance will be highest.

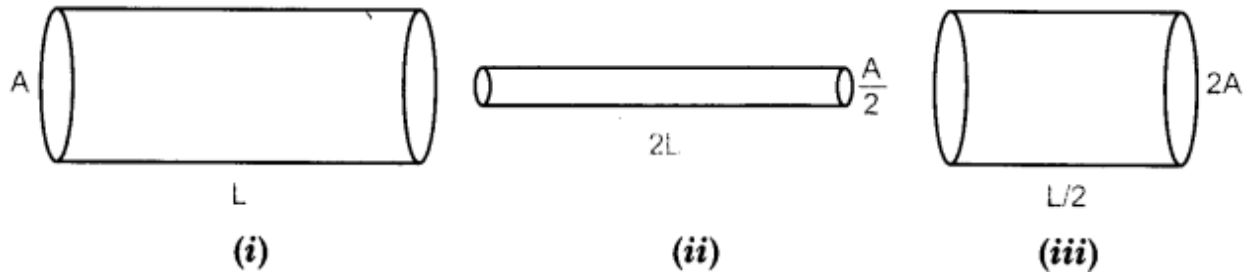

SECTION-C

This section has 02 case-based questions (14 and 15). Each case is followed by 03 sub-questions (a, b and c). Parts a and b are compulsory. However, an internal choice has been provided in part c.

Mendel was educated in a monastery and went on to study science and mathematics at the University of Vienna. Failure in the examinations for a teaching certificate did not suppress his zeal for scientific quest. He went back to his monastery and started growing peas. Many others had studied the inheritance of traits in peas and other organisms earlier, but Mendel blended his knowledge of science and mathematics and was the first one to keep count of individuals exhibiting a particular trait in each generation. This helped him to arrive at the laws of inheritance.

Q.14. Based on the above information, answer the following questions.

- (a) Why did Mendel select a pea plant for his experiments?
- (b) The given picture represents the alleles for flower colour in pea plants.

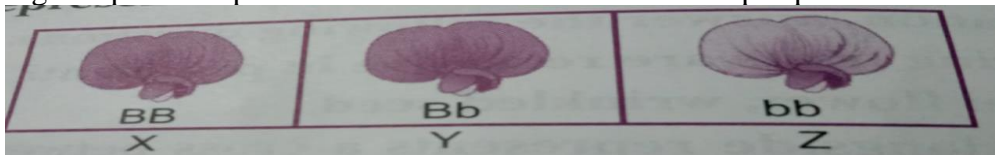

Flower “Y” has same colour as that of flower “X”. Why?

(c) Study the picture below that represents traits studied by Mendel in garden pea.

	Seed		Flower		Pod		Stem	
Form	Cotyledons	Color	Form	Color	Place	Size		
ROUND	YELLOW	WHITE	FULL	YELLOW	AXIAL FLOWERS	TALL		
WRINKLED	GREEN	PURPLE	CONSTRICTED	GREEN	TERMINAL FLOWERS	SHORT		

Identify the dominant trait in pod colour and stem place.

OR

When a pure tall plant (TT) is crossed with a short plant (tt), what will be the ratio of pure tall plants to short plants in F_2 ?

It is well known that “magnetic field is caused by electric current.” Whenever there is a change in magnetic flux linked with a coil (or circuit) an emf is induced in the coil. This phenomenon is called electromagnetic induction.

The emf produced in the coil is called the induced emf. If the coil is closed, the current thus produced is called as induced current.

The direction of induced current is determining by Fleming’s right hand rule.

These induced current are used in a moving coil microphone, tape-recorders, video recorders, hard-discs in computers etc.

Q.15. Based on the above information, answer the following questions

- (a) State Faraday’s law of electromagnetic induction.
- (b) What determines the direction of induced current? State that law.
- (c) State any two methods of inducing current in a coil.

OR

A student connects a coil of wire with a sensitive galvanometer as shown in figure. Where should the bar magnet be placed to cause the deflection in the galvanometer?

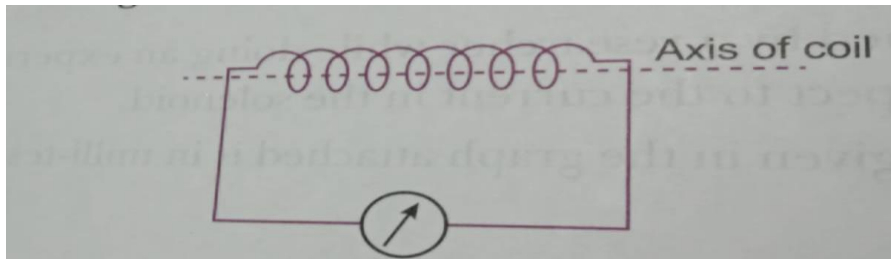

MARKING SCHEME OF SAMPLE QUESTION PAPER2

SCIENCE CLASS-X

TERM-II (2021-22)

Max. Marks: 40

Time allowed: 2 hours

Marking Scheme

Ans. 1. 1+1

(i)Catenation: Carbon has the unique ability to form bonds with other atoms of carbon, giving rise to large molecules. This property is called catenation.



(ii)Tettravalency: Since carbon has a valency of four, it is capable of bonding with four other atoms of carbon or atoms of some other mono-valent elements. In order to satisfy its tettravalency, carbon can form double or triple bonds with other C-atoms or with oxygen, nitrogen also.

Ans.2. 1+1

(a)The atomic number of this element is obtained by adding all the electrons present in its electronic configuration.

$$\text{Atomic number}=2+8+7=17$$

(b)The electronic configuration of the given element =K L M

$$2, 8, 7$$

Valence electron in its atom=7

This element will be chemically similar to that element which has the same valence electron

(7).The electronic configurations of the above elements are:

(i)N (7): K L (5 valence electrons)

$$2, 5$$

(ii)F (9): K, L (7 valence electrons)

$$2, 7$$

(iii)P (15): K, L,M (5 valence electrons)

$$2, 8, 5$$

(iv) Ar (18): K, L, M

2, 8, 8

F (9) has 7 valence electrons just like that of the given element. Hence, the given element of atomic number 17 will be chemically similar to the element fluorine(F) of atomic number 9.

Ans.3. 1+1

(a)When implantation of embryo has occurred the uterine wall thickens and is richly supplied with blood to nourish the growing embryo.

(b)The thick and spongy lining of the uterus slowly breaks and comes out through the vagina as blood and mucus.

Ans .4. 1+1

(a)

Dominant trait	Recessive trait
1. The trait which appears in the F1 progeny is dominant.	1. The trait which remains hidden or which does not appear in the F1 progeny is recessive trait.
2.It appears in more numbers	2.It appears in less number

(b) 75% of the plants were with round seeds.

OR

Mendel explained this through his monohybrid cross. He produced progeny from purely dwarf and purely tall plant of pea..He found that all F1 progeny were tall. When F1 plants are self pollinated then in F2 progeny 25% plants were dwarf and 75% plants were tall. This shows that both dwarfness and tallness were inherited in F1 progeny but dwarfness was suppressed under the dominance of other. (2)

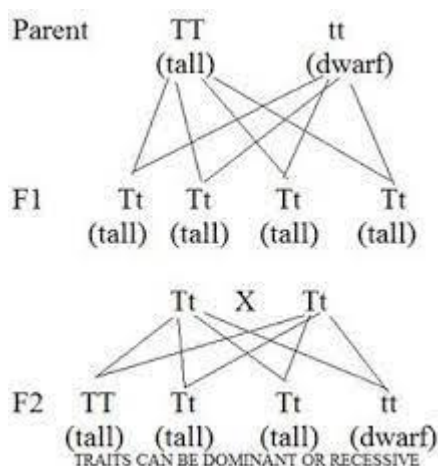

Ans.5. 1+1

(a) If the current in the wire is increased, the deflection increases. The strength of magnetic field is directly proportional to the magnitude of current passing through the straight conductor.

(b) The divergence, that is, the falling degree of closeness of magnetic field lines indicates the fall in strength of magnetic field near and beyond the ends of the solenoid.

OR

The lines representing the magnetic field are called magnetic field lines. They have the following characteristics-

$$\frac{1}{2} + \frac{1}{2} + \frac{1}{2} + \frac{1}{2} = 2$$

(i) Two magnetic field lines never intersect at a point.

(ii) They are always arranged in the form of closed concentric circles outside the magnet and move from North to South.

(iii) They are uniform, straight and produce inside the magnet and move from South to North.

(iv) They are denser and stronger near the poles and weaker when wider apart.

Ans.6. 1+1

(a) Spore formation in Rhizopus-This is an asexual method of reproduction in bacteria and fungi. Spores are unicellular bodies formed by cell division in a parent organism. After detaching from the parent, and if conditions are suitable, they germinate directly or indirectly into a new individual.

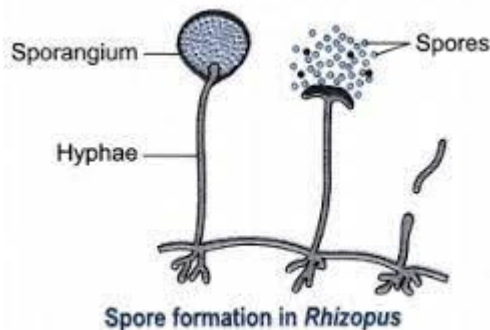

(b) Multiple fission in Plasmodium: It is an asexual mode of reproduction in organisms. Here, the nucleus of the organism divides repeatedly to form a number of equal sized daughter nuclei and each daughter nuclei breaks away together with a small portion of the cytoplasm.

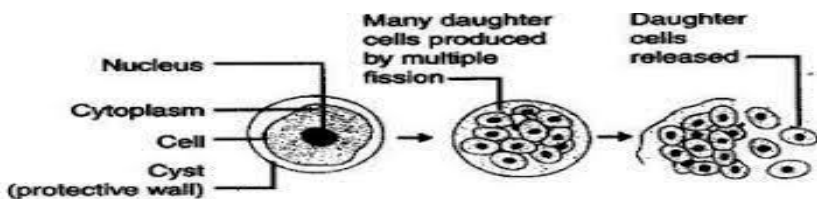

Ans .7. Removal of lions from the mentioned food chain will increase the number of deer to such an extent that they will eat up the whole grass. The density of producer like grass will be very much reduced and this will turn the area into desert. (2)

OR

The food chain in the given situation will be: (2)

Phytoplankton → Zooplankton → Mosquito larva → Frogs

In the absence of frogs more mosquito larvae survived giving rise to large number of mosquitoes. The large number of mosquitoes caused increased incidences of malaria.

SECTION-B

Ans.8. 1+1+1

(a) C_2H_6 is saturated hydrocarbon.

(b) $-COOH$ (carboxylic acid) is functional group in compound B.

(c) C_3H_6 , C_4H_8 are next two members of homologous series of compound A.

OR

1+1+1

(i) **Ethane:** The molecular formula is C_2H_6

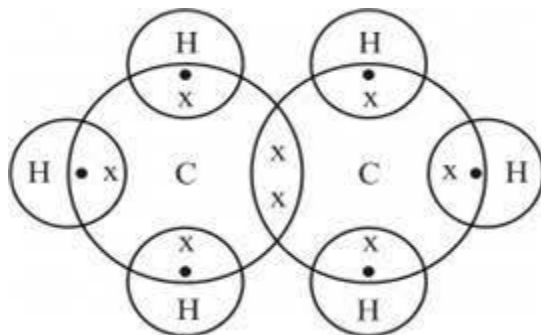

(ii) **Ethene:** The molecular formula is C_2H_4

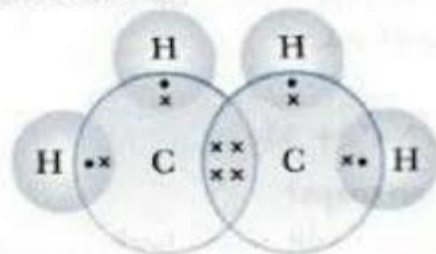

(iii) Ethyne: The molecular formula is C_2H_2

Electron-dot structure:

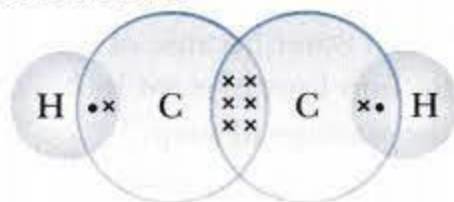

Ans.9.

1+1+1

- (a) 'C' will be non-metal because it has 7 valence electrons, it can gain one electron easily.
 (b) 'A' is more active element than 'C' because 'A' can gain electron easily.
 (c) 'C' will gain electron to become negative ion, ie. anion because it will have electrons more than protons.

Ans.10.

1+1+1

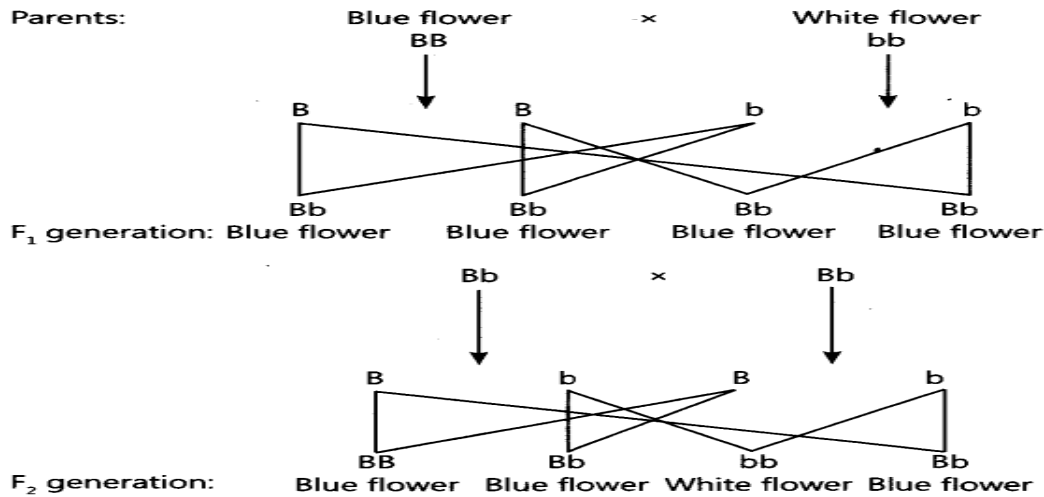

- (a) The colour of all the flowers in F₁ generation will be blue.
 (b) Percentage of white flower plants in F₂ generation will be 25.
 (c) The ratio of genotype BB and Bb in F₂ progeny will be 1 : 2.

Ans.11. 1+2

Greater than slope of V-I graph, greater will be the resistance of given metallic wire. In the given graph, wire A has greater slope than B. Hence, wire A has greater resistance.

For the wires of same length and same thickness, resistance depends on the nature of material of the wire, i.e.

$$R_1 = \rho_1 \frac{l}{A} \quad \text{and} \quad R_2 = \rho_2 \frac{l}{A}$$

$$\Rightarrow \frac{R_1}{R_2} = \frac{\rho_1}{\rho_2} \quad \text{or} \quad R \propto \rho$$

Hence, wire 'A' is made of a material of high resistivity.

OR.

1+1+1

- (a) Electric power: It is the rate of doing work by an energy source or the rate at which the electrical energy is dissipated or consumed per unit time in the electric circuit is called electric power

So,

$$\begin{aligned} \text{Power } P &= \frac{\text{Work done } (w)}{\text{Time } (t)} \\ &= \frac{\text{Electrical energy dissipated}}{\text{Time } (t)} \\ &= VI = \frac{V^2}{R} \end{aligned}$$

(b) It means, the maximum current will flow through it is only 2 A. Fuse wire will melt if the current exceeds 2 A value through it.

(c) Given: $P = 1 \text{ kW} = 1000 \text{ W}$, $V = 220 \text{ V}$

$$\text{Current drawn, } I = \frac{P}{V} = \frac{1000}{220} = \frac{50}{11} = 4.54 \text{ A}$$

To run electric iron of 1 kW, rated fuse of 5 A should be used.

Ans.12. 1+2

(a) Indiscriminate use of pesticides may result in the degradation of environment. For example, DDT is an organic pesticide which is used to kill pests in crop fields. When it is used in large quantity it can be passed along the food chain from crops to man or other animals and birds and can harm them.

(b) The harmful by-products are gases such as SO_2 and NO . They cause extensive air pollution and are responsible for acid rain.

Ans.13. 1+1+1

For geometrical shape shown in

Figure (i) $R_1 = \rho \frac{L}{A}$

Figure (ii) $R_2 = \rho \frac{2L}{A/2} = 4 \left(\rho \frac{L}{A} \right) = 4R_1$

Figure (iii) $R_3 = \rho \frac{L/2}{2A} = \frac{1}{4} \left(\rho \frac{L}{A} \right) = \frac{R_1}{4}$

SECTION-C

Ans 14. 1+1+2

(a) Mendel selected pea plant because:

The pea plant can be easily grown and has several contrasting characters. Many generations can be studied within short period of time.

(b) Flowers X and y have same colour because their genotype consists of a dominant allele. The dominant allele expresses itself even in the presence of recessive allele. X and Y both have same colour because they both have dominant allele B.

(c) Yellow pod colour and axial position are dominant traits.

OR

The ratio would be 1:1

Ans.15.

1+1+2

(a) Whenever the magnetic field lines linked with a coil change due to relative motion of a magnet and the coil, an induced current is produced in the coil. The magnitude of induced current is directly proportional to the rate of change of number of magnetic field lines linked to the coil.

(b) Fleming's right hand rule. It states that if we stretch our right hand in such a way that the thumb, forefinger and central finger remain perpendicular to each other, so that the forefinger indicates the direction of the magnetic field and the thumb in the direction of motion of conductor; then the central finger indicates the direction of induced current.

(c) Current can be induced in a coil by

- Moving a magnet towards or away from the coil

- Moving a coil towards or away from a magnet

- Rotating a coil within a magnetic field.

OR

The bar magnet should be moved towards or away from the coil and parallel to the axis of the coil.

**KENDRIYA VIDYALAYA SANGATHAN RO
RAIPUR TERM 2 EXAMINATION (2021-
22) BLUEPRINT**

CLASS -X SCIENCE

MAX. MARKS: 40

General Instructions:-

- All questions are compulsory.
- The question paper has **Three sections** and **15 questions**. All questions are compulsory.
- Section - A has 7 questions of 2 marks each; Section - B has 6 questions of 3 marks each; and Section - C has 2 case-based questions of 4 marks each.
- Internal choices have been provided in some questions. A student has to attempt only one of the alternatives in such questions.

S.N.	NAME OF THE CHAPTER	Section A	Section B	Section C	TOTAL	
1.	Carbon and its compounds	2(1)	3(1)	--	5(2)	
2	Periodic classification of elements	2(1)	3(1)	--	5(2)	
3.	How do organisms reproduce	2(2)	--	--	4(2)	
4.	Heredity and evolution	2(1)	3(1)	4(1)	9(3)	
5.	Electricity	-	3(2)	--	3(2)	
6.	Magnetic Effects of Electric Current	2(1)	--	4(1)	6(2)	
7.	Our environment	2(1)	3(1)	--	5(2)	
	TOTAL	14(7)	18(6)	8(2)	40(15)	

KENDRIYA VIDYALAYA SANGATHAN, RAIPUR REGION
MODEL QUESTION PAPER
CLASS-X SCIENCE
TERM-II (2021-22)

Max.Marks:40

Timeallowed:2hours

General Instructions:

- i) All questions are compulsory.
- ii) The question paper has **three sections** and **15 questions**. All questions are compulsory.
- iii) Section-A has 7 questions of 2 marks each; Section-B has 6 questions of 3 marks each; and Section-C has 2 case based questions of 4 marks each.
- iv) Internal choices have been provided in some questions. A student has to attempt only one of the alternatives in such questions.

SECTION-A			
1	The atomic number of three elements are given below		2
	Element (symbol)	A	B
	Atomic number	5	7
	Write the symbol of the element which belongs to (i) Group 13, (ii) Group 15, of the periodic table.		
2	What are isomers? Draw the structures of two isomers of butane, C ₄ H ₁₀		2
3	Illustrate the following with the help of suitable diagrams: (i) Regeneration in Planaria. (ii) Budding in Hydra.		2
4	a) Name the parts labeled A, B, C, D .		2

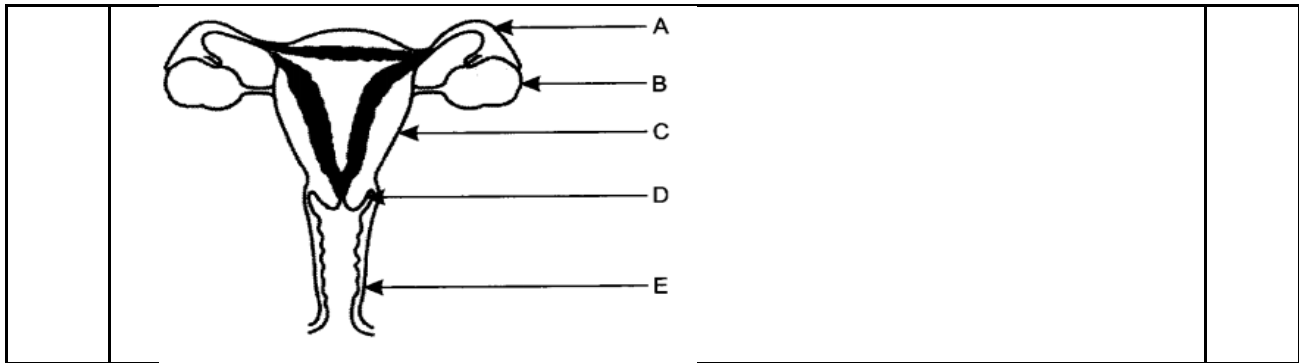

5 A husband has 46 chromosomes. His wife has 46 chromosomes. Then why do not their offspring has 46 pairs of chromosomes which is obtained by the fusion of male and female gametes? Support your answer with a neat illustration.

2

OR

In an asexually reproducing species, if a trait X exists in 7% of a population and trait Y exists in 80% of the same population, which of the two trait is likely to have arisen earlier? Give reason.

6 . What is Fleming’s left hand rule? What is the direction of the force acting on the proton?

2

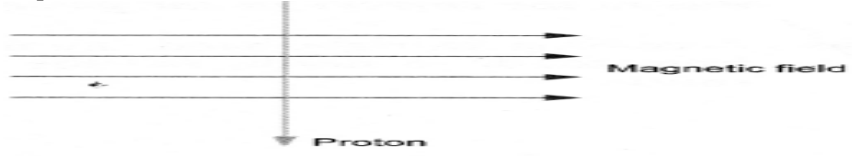

OR

Identify North and south poles of a magnet in the figure. What is the direction of magnetic field lines outside a bar magnet?

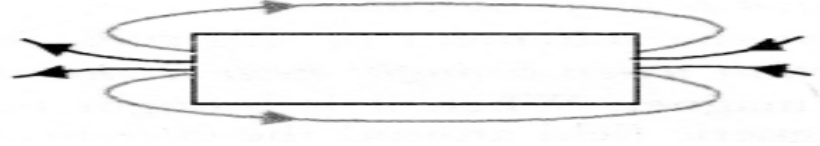

7 In the following food chain, 5 J of energy is available to man. How much energy was available at the producer level?

2

Plants → Sheep → Man

OR

What is depicted in the scheme? Name any two non-biodegradable wastes.

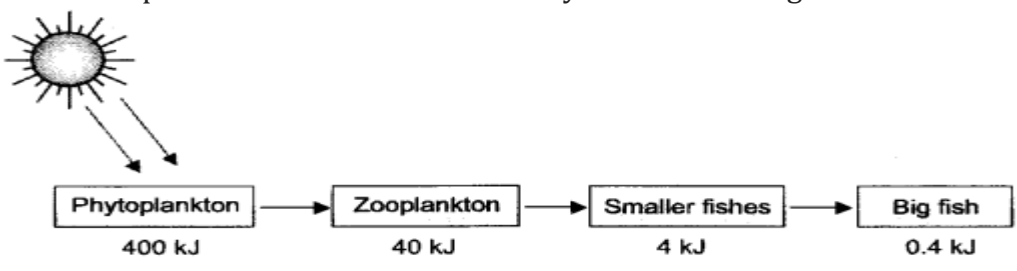

SECTION-B

8	<p>The elements of the third period of the Periodic Table are given below:</p> <p>(a) Which atom is bigger, Na or Mg? Why?</p> <p>(b) Identify the most (i) metallic and (ii) non-metallic element in Period 3.</p> <table border="1" style="margin: 10px auto; border-collapse: collapse; text-align: center;"> <tr> <td style="padding: 5px;">Group</td> <td style="padding: 5px;">I</td> <td style="padding: 5px;">II</td> <td style="padding: 5px;">III</td> <td style="padding: 5px;">IV</td> <td style="padding: 5px;">V</td> <td style="padding: 5px;">VI</td> <td style="padding: 5px;">VII</td> </tr> <tr> <td style="padding: 5px;">Period 3</td> <td style="padding: 5px;">Na</td> <td style="padding: 5px;">Mg</td> <td style="padding: 5px;">Al</td> <td style="padding: 5px;">Si</td> <td style="padding: 5px;">P</td> <td style="padding: 5px;">S</td> <td style="padding: 5px;">Cl</td> </tr> </table>	Group	I	II	III	IV	V	VI	VII	Period 3	Na	Mg	Al	Si	P	S	Cl	3
Group	I	II	III	IV	V	VI	VII											
Period 3	Na	Mg	Al	Si	P	S	Cl											
9	<p>a) Which of the following belong to the same homologous series? C₃H₈, C₄H₈, C₄H₆, C₃H₆.</p> <p>(b) A compound with molecular formula C₂H₆O is used as a fuel. Identify the compound</p> <p>(c) Select the saturated hydrocarbons from the following: C₃H₆; C₅H₁₀; C₄H₁₀; C₆H₁₄; C₂H₄</p> <p>OR</p> <p>Draw three structural isomers of pentane?</p>	3																

10	<p>A blue colour flower plant denoted by BB is cross bred with that of white colour flower plant denoted by bb.</p> <p>(a) State the colour of flower you would expect in their F₁ generation plants.</p> <p>(b) What must be the percentage of white flower plants in F₂ generation if flowers of F₁ plants are self-pollinated?</p> <p>(c) State the expected ratio of the genotypes BB and Bb in the F₂ progeny</p>	3
11	<p>(a) Though same current flows through the electric line wires and the filament of bulb, yet only the filament glows. Why?</p> <p>(b) The temperature of the filament of bulb is 2700°C when it glows. Why does it not get burnt up at such high temperature?</p> <p>(c) What is the commercial unit of electric energy? Convert it into joules.</p>	3

12	<p>(a) A current of 4 A flows through a 12V car headlight bulb for 10 minutes. How much energy transfer occurs during this time?</p> <p>(b) A heating element is marked 210 V, 630 W. What is the current drawn by the element when connected to a 210 V D.C. mains? What is the resistance of the element?</p> <p>OR</p> <p>A household uses the following electric appliances:</p> <p>(i) Refrigerator of rating 400 W for ten hours each day.</p> <p>(ii) Two electric fans of rating 80 W each for twelve hours each day.</p> <p>(iii) Six electric tubes of rating 18 W each for 6 hours each day.</p> <p>Calculate the electricity bill of the household for the month of June if the cost per unit of electric energy is ₹ 3.00.</p>	3
13	<p>(a) What is an ecosystem? List its two main components.</p> <p>(b) We do not clean ponds or lakes but an aquarium needs to be cleaned regularly. Explain.</p> <p>(c) Write the full form of CFC.</p>	3

SECTION-C

This section has two case-based questions (14 and 15). Each case is followed by 03 sub-questions (a, b and c). Parts a and b are compulsory. However, an internal choice has been provided in part c.

14	<p>A scientist cross pure-bred tall (dominant) pea plant with pure-bred dwarf (recessive) pea plant he will get pea plants of F₁ generation. If now self-cross the pea plant of F₂ generation is done, then we obtain pea plants of F₂ generation.</p> <p>(a) What do the plants of F₂ generation look like?</p> <p>(b) State the ratio of tall plants to dwarf plants in F₂ generation.. Write the full form of DNA.</p> <p>(c) State the type of plants not found in F₂ generation but appeared in F₂ generation, mentioning the reason for the same</p> <p>OR</p> <p>(c) How does the creation of variations in a species promote survival?</p>	4
----	--	---

15	<p>A wire made up of copper is wound on a cylindrical core. The outer surface of the wire is insulated, therefore it carry current only inside it and not along its out surface. It also protects leakage of current from one turn to another. This arrangement will be referred to as a coil in this experiment. Now a student connects this coil to a galvanometer. What would happen if a bar magnet is</p> <p>(i) Pushed into the coil with its north pole entering first? (ii) Pulled out of the bar magnet? What is the principle of electric motor? (iii) Held stationary inside the coil</p> <p style="text-align: center;">OR</p> <p>(iii)What is The shape of the magnetic field lines produced by a current carrying conductor?</p>	4
----	---	---

Marking scheme

CLASSX Science (086)

Pre-Term2(2021-22)

1. (i) A - 1mark
(ii) B -1mark

2. Isomers are compounds having the same molecular formula but different structures.(1 mark)

The two isomers of butane, C₄H₁₀ are:

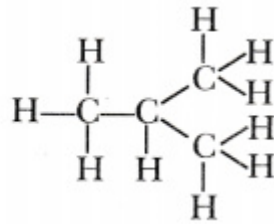
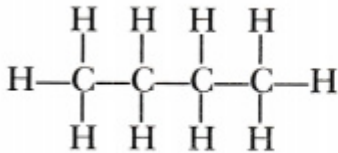

(1/2 mark for each

structure)

3. (1 mark for each diagram)

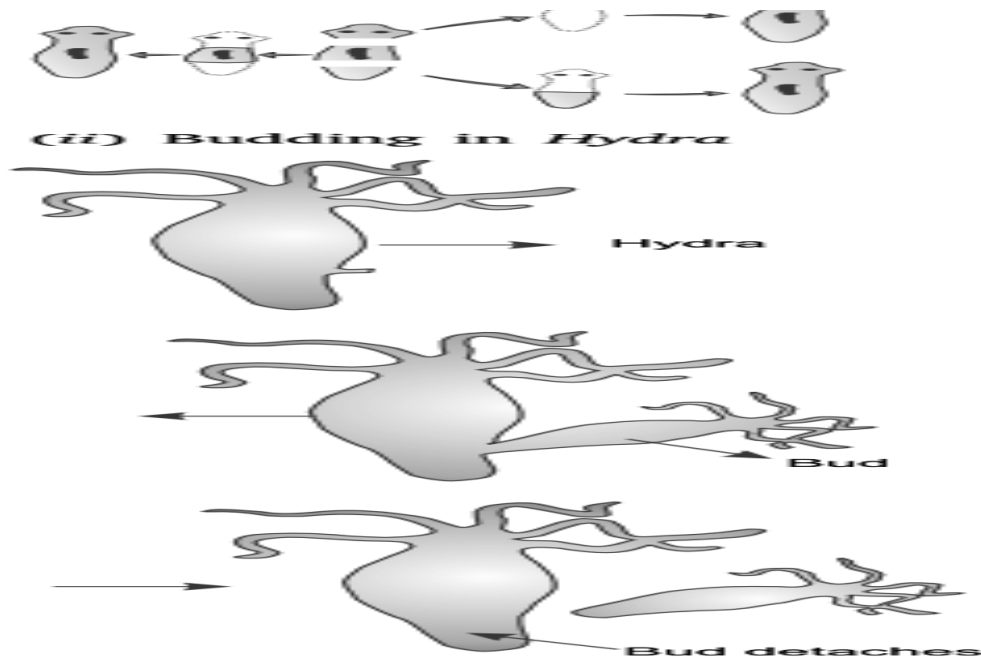

4.

- A----Fallopian Tube (1/2*4=2 marks)
- B-----Ovary
- C-----Uterus
- D----- Cervix

5.

Gametes do not possess the same number of chromosomes as are present in individuals. Meiosis occurs prior to formation of gametes. This reduces the number of chromosomes to one half in gametes. In humans, the gametes carry only 23 chromosomes (one half of 46). Fusion of two gametes restores the number of 46 chromosomes in the zygote. Therefore, the human offspring does not have 46 pairs of chromosomes.

(1 mark for explanation and 1 mark for

illustration)

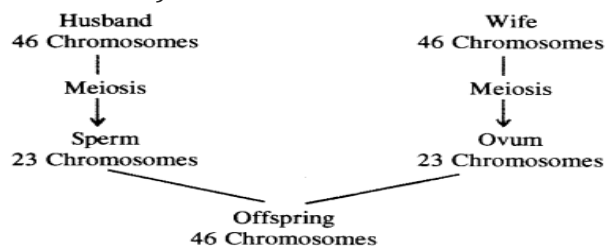

OR

Trait Y which exists in 80% (larger fraction) of the population, is likely to have arisen earlier because in asexual reproduction, identical copies of DNA are produced and variations don't occur. (1 mark)

New traits come in the population due to sudden mutation and then are inherited. 80% of the population with trait Y is likely to have been replicating that trait for a longer period than 7% of population with trait X. (1mark)

6. According to Fleming's left hand rule, the force acting on a current carrying conductor placed at right angles to a magnetic field is perpendicular to the directions of current {i.e. flow of positive charges} and the magnetic field. (1 mark)

The arrow showing the direction of proton represents the direction of current in a conductor, therefore, the force acting on the conductor is perpendicular to the plane of the paper and in upward direction. (1 Mark)

OR

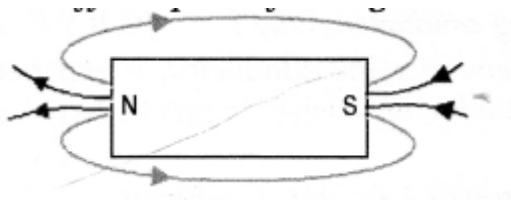

(1 mark for identifying pole)

From North Pole to South pole outside the magnet. (1 mark)

7. Man 5 J, sheep $5 \times 10 = 50$ J, plants $50 \times 10 = 500$ J (1 mark for each step)

OR

It is a food chain that is depicting 10% law of energy. (1 mark)

Waste plastic articles, polythene bags, many pesticides like DDT ($1/2 \times 2 = 1$ mark)

8. (a) Na is bigger because size of atom decreases on moving left to right in a period. (1 mark)

(b) Most metallic- sodium, non-metallic- chlorine (1 mark, 1 mark)

9.a. C_3H_6 and C_4H_8 belong to the same homologous series which is alkenes with general formula C_nH_{2n} . ($1/2 \times 2 = 1$ mark)

b. The compound is ethanol with formula C_2H_5OH . (1 mark)

c. The compounds C_4H_{10} (butane) and C_6H_{14} (hexane) are saturated hydrocarbons. They correspond to the molecular formula C_nH_{2n+2} . ($1/2 \times 2 = 1$ mark)

OR

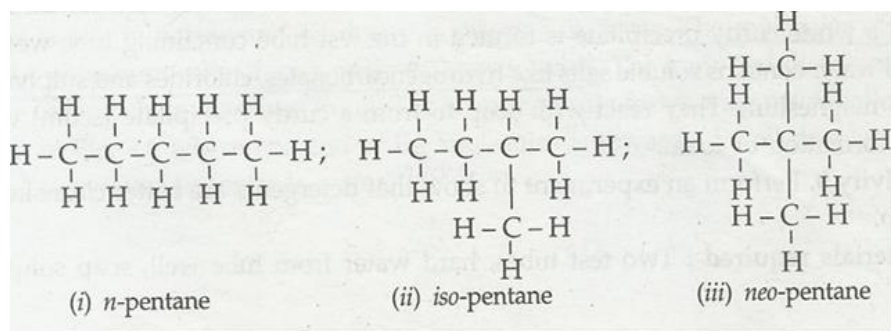

(1 mark for each structure)

10.

Parents:

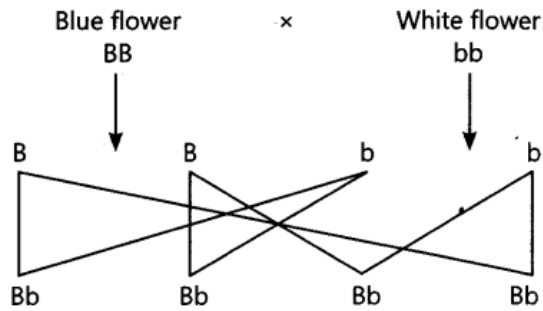

F₁ generation: Blue flower Blue flower Blue flower Blue flower

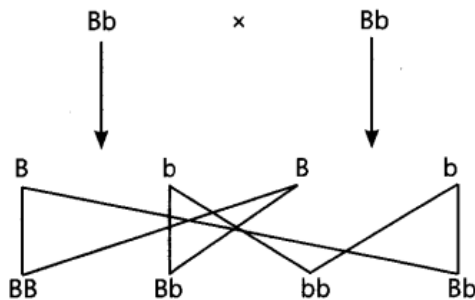

F₂ generation: Blue flower Blue flower White flower Blue flower

- (a) The colour of all the flowers in F₁ generation will be blue.
- (b) Percentage of white flower plants in F₂ generation will be 25.
- (c) The ratio of genotype BB and Bb in F₂ progeny will be 1 : 2.

(1 mark each for correct points a,b,c)

11.

(a) Electric line wires offer extremely low resistance to the flow of current, so they do not glow because negligible heat is produced in it. The filament of bulb glows because it becomes red hot due to large amount of heat produced, as it offers high resistance to the flow of current through it. (1 mark)

(b) The filament of bulb when it glows at 2700°C does not get burnt because the tungsten metal of filament has

(i) a very high melting point (of 3380°C) and

(ii) a high resistivity

(1 mark)

(c) Kilowatt hour – Commercial unit of electrical energy

$$1 \text{ kWh} = 1000 \text{ Wh} = 1000 \text{ J/S} \times 3600 \text{ sec} \\ = 3600000 \text{ J} = 3.6 \times 10^6 \text{ J}$$

(1 mark)

12.(a) Given : $I = 4 \text{ A}$, $V = 12 \text{ V}$, $t = 10 \text{ min} = 600 \text{ s}$

$$\text{Energy transferred} = V \cdot I \cdot t = 12 \times 4 \times 600 = 28800 \text{ J. (1 mark)}$$

(b) Given, $P = 630 \text{ W}$, $V = 210 \text{ V}$

$$\text{Current drawn, } I = \frac{P}{V} = \frac{630}{210} = 3 \text{ A} \quad (1 \text{ mark})$$

$$\text{Resistance} = \frac{\text{voltage}}{\text{current}} = \frac{210}{3} = 70 \text{ ohms} \quad (1 \text{ mark})$$

OR

Energy consumed by refrigerator of rating 400 W for ten hours each day

$$= P \times t = 400 \text{ W} \times 10 \text{ h} = 4000 \text{ Wh} = 4.0 \text{ kWh} \quad (1/2 \text{ mark})$$

Energy consumed by two electric fans of rating 80 W each for twelve hours each day

$$= 2 \times P \times t = 2 \times 80 \text{ W} \times 12 \text{ h} = 1600 \text{ Wh} = 1.6 \text{ kWh} \quad (1/2 \text{ mark})$$

Energy consumed by six electric tubes of rating 18 W each for 6 hours each day

$$= 6 \times P \times t = 6 \times 18 \text{ W} \times 6 \text{ h} = 648 \text{ Wh} = 0.648 \text{ kWh} \quad (1/2 \text{ mark})$$

Total energy consumed in the month of June (30 days)

$$= (4.0 + 1.6 + 0.648) \times 30 \text{ kWh} = 6.248 \times 30 = 187.44 \text{ kWh} \quad (1/2 \text{ mark})$$

Electricity bill for the month of June

$$= 187.44 \times 3 = 562.32 = \text{Rs } 562 \text{ (approx.)} \quad (1 \text{ mark})$$

13.. (a) **Ecosystem:** It is self contained ecological system, which consists of a distinct, biotic community and the physical environment both interacting and exchanging materials between them.

Main Components,

1. Biotic, e.g., producers, consumers
2. Abiotic, e.g., climatic factors, inorganic nutrients. (1 mark)

(b) Cleaning an aquarium:
An aquarium is an artificial system which is also incomplete due to absence of producers, food chains and decomposers. There is no recycling and self cleaning. However, a pond or a lake is a self sustained, natural and complete ecosystem where there is perfect recycling of nutrients. (1 mark)

(c) Chlorofluorocarbon. (1 mark)

14. (a) All plants of F_1 generation will be tall plants. (1 mark)

(b) 3:1, Deoxyribonucleic acid (1+1=2 mark)

(c) Dwarf trait is recessive trait which was not expressed in the F_1 generation; the recessive trait gets expressed in the F_2 generation after self pollination (1 mark)

OR

Variations promote the survival of the species as they allow them to adapt and survive to the changing environment and conditions. Different species have different kinds of advantages depending on the nature of variation.(1 mark)

15

(i) A deflection is observed in the galvanometer due to the induced current because of the changing magnetic flux (increasing) through the turns of the coil connected to the galvanometer. (1 mark)

(ii) A deflection is again observed in the galvanometer, as when it is pulled out, the flux linked with the coil due to the bar magnet decreases. Hence a current flows in the coil to reduce the change in flux. The deflection can be observed in the opposite direction as compared with the previous case. (1 mark)

The principle of electric motor is when a rectangular coil is placed in a magnetic field and current is passed through it ,the coil rotates as a result of forces acting on the coil. (1 mark)

(iii) No deflection is observed in the galvanometer. The flux linked with the coil due to the magnetic field is at a constant. Hence no current is induced due to the bar magnet.(1 mark)

OR

Concentric circles (1 mark)